

ES-PDS-ES32H040xLQ_V1.0.PrjPCB

Table of Contents

Sheet1: Cover(This Page)

Sheet2: ES-PDS-ES32H040xLQ_V1.0.PrjPCB

Legend

General comment such as function title, configuration, ...

Text to be added to silkscreen.

Warning text.

Notes to generate the board layout.

ES-PDS-ES32H040xLQ
ES-PDS-ES32H040xLQ_V1.0.SchDoc



Eastsoft®

essemi
上海东软载波微电子有限公司

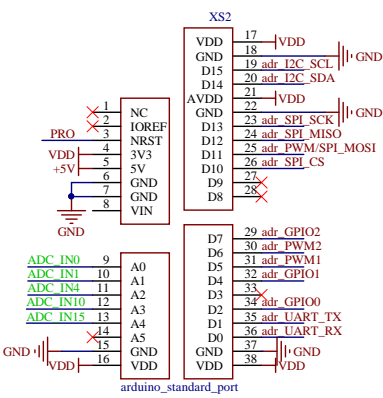
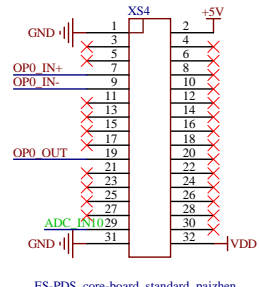
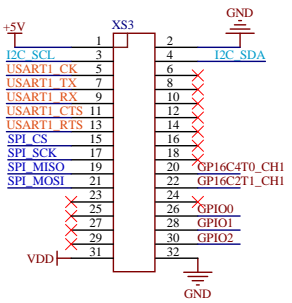
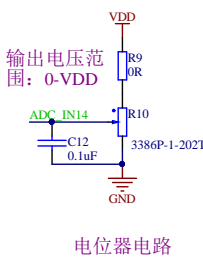
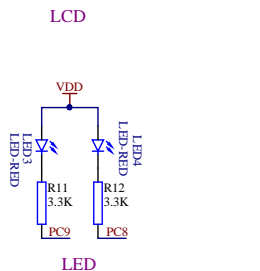
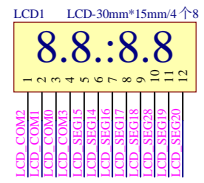
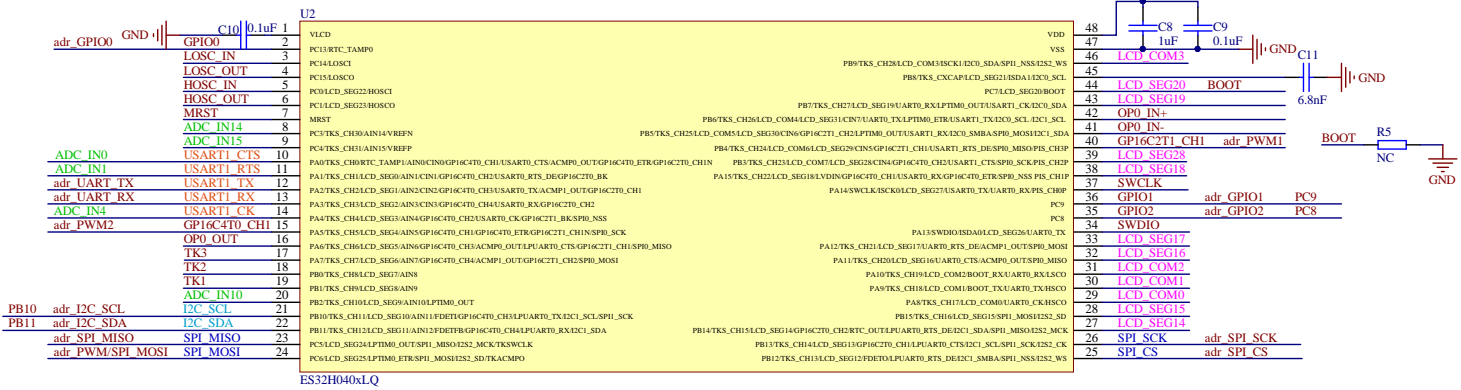
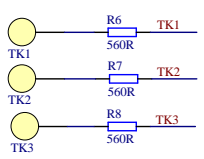
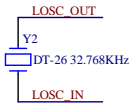
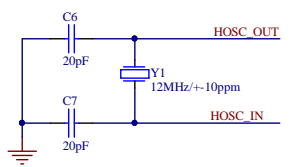
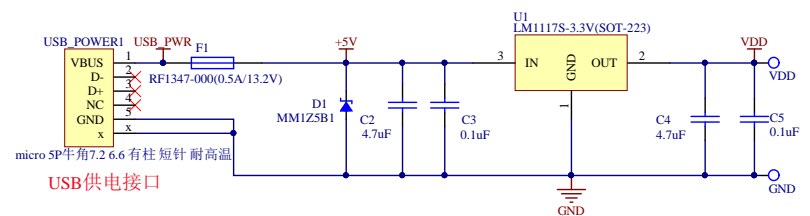
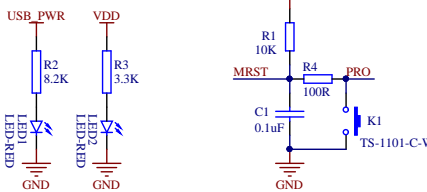
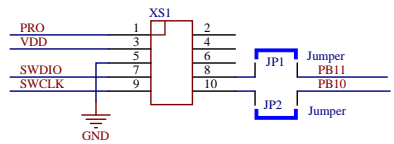

Title:	ES-PDS-ES32H040xLQ_V1.0.SchDoc
Project:	ES-PDS-ES32H040xLQ_V1.0.PrjPCB
Version:	V1.0
Date:	2020-12-25
Size:	A3
Sheet:	1 of 1



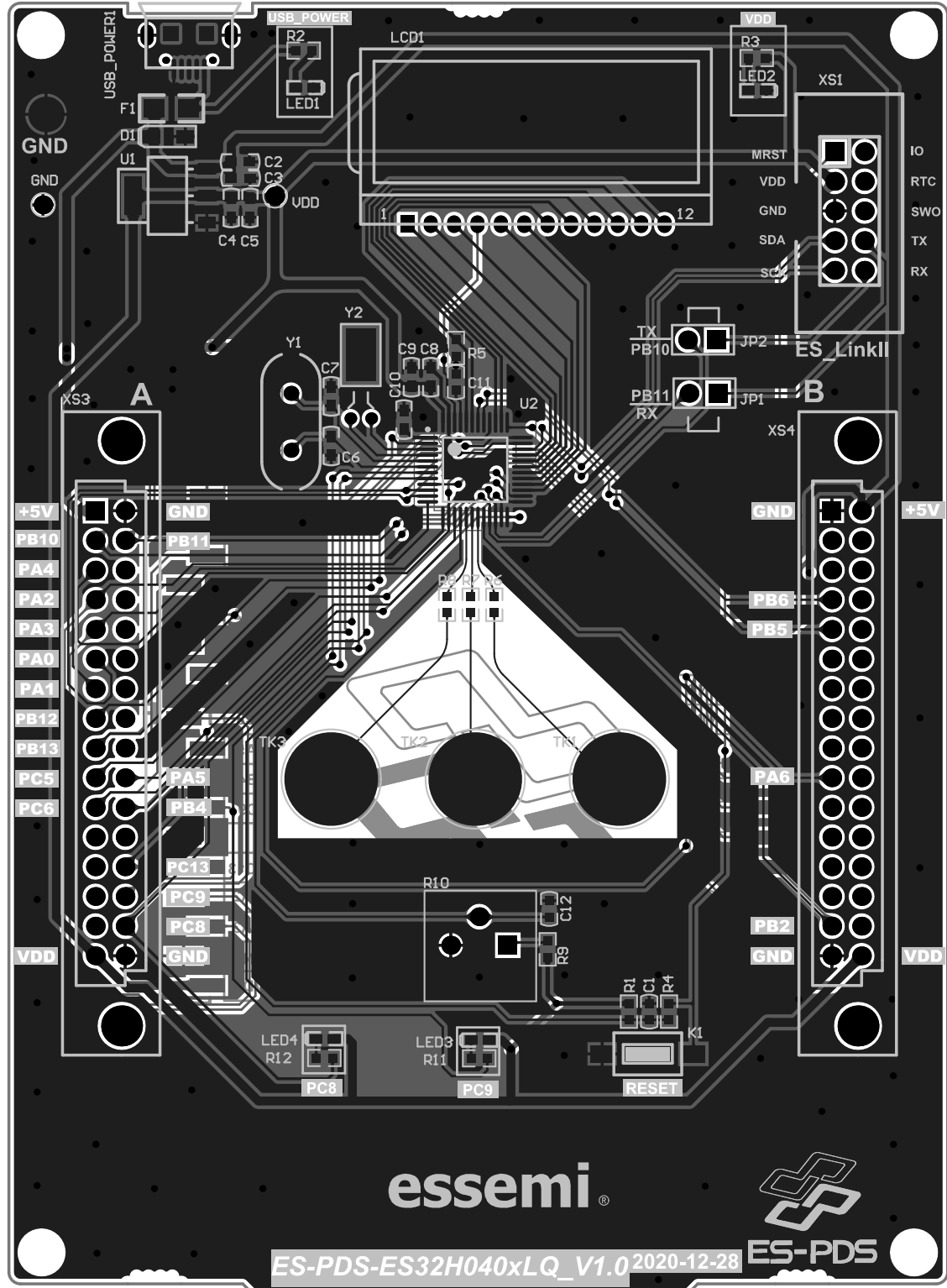

essemi®



ES-PDS-ES32H040xLQ_V1.0 2020-12-28

ES-PDS